

PHILIPS



VCR

VIDEO CASSETTE RECORDER

VR 337



PHILIPS



**Table of channel frequencies
PAL-B,G:**

channel	wave-band	frequency (Mhz)	channel	wave-band	frequency (Mhz)
e2	VHF I	48,25	e60	UHF	783,25
e3	VHF I	55,25	e61	UHF	791,25
e4	VHF I	62,25	e62	UHF	799,25
e5	VHF III	175,25	e63	UHF	807,25
e6	VHF III	182,25	e64	UHF	815,25
e7	VHF III	189,25	e65	UHF	823,25
e8	VHF III	196,25	e66	UHF	831,25
e9	VHF III	203,25	e67	UHF	839,25
e10	VHF III	210,25	e68	UHF	847,25
e11	VHF III	217,25	e69	UHF	855,25
e12	VHF III	224,25	-	VHF I	69,25
-	VHF I	53,75	-	VHF I	76,25
-	VHF I	62,25	-	VHF I	83,25
-	VHF II	82,25	-	VHF II	90,25
-	VHF III	175,25	-	VHF II	97,25
-	VHF III	183,25	-	VHF II	104,25
-	VHF III	192,25	s1	VHF I	105,25
-	VHF III	201,25	s2	VHF III	112,25
-	VHF III	210,25	s3	VHF III	119,25
e21	UHF	471,25	s4	VHF III	126,25
e22	UHF	479,25	s5	VHF III	133,25
e23	UHF	487,25	s6	VHF III	140,25
e24	UHF	495,25	s7	VHF III	147,25
e25	UHF	503,25	s8	VHF III	154,25
e26	UHF	511,25	s9	VHF III	161,25
e27	UHF	519,25	s10	VHF III	168,25
e28	UHF	527,25	s11	VHF III	231,25
e29	UHF	535,25	s12	VHF III	238,25
e30	UHF	543,25	s13	VHF III	245,25
e31	UHF	551,25	s14	VHF III	252,25
e32	UHF	559,25	s15	VHF III	259,25
e33	UHF	567,25	s16	VHF III	266,25
e34	UHF	575,25	s17	VHF III	273,25
e35	UHF	583,25	s18	VHF III	280,25
e36	UHF	591,25	s19	VHF III	287,25
e37	UHF	599,25	s20	VHF III	294,25
e38	UHF	607,25	s21	HYP	303,25
e39	UHF	615,25	s22	HYP	311,25
e40	UHF	623,25	s23	HYP	319,25
e41	UHF	631,25	s24	HYP	327,25
e42	UHF	639,25	s25	HYP	335,25
e43	UHF	647,25	s26	HYP	343,25
e44	UHF	655,25	s27	HYP	351,25
e45	UHF	663,25	s28	HYP	359,25
e46	UHF	671,25	s29	HYP	367,25
e47	UHF	679,25	s30	HYP	375,25
e48	UHF	687,25	s31	HYP	383,25
e49	UHF	695,25	s32	HYP	391,25
e50	UHF	703,25	s33	HYP	399,25
e51	UHF	711,25	s34	HYP	407,25
e52	UHF	719,25	s35	HYP	415,25
e53	UHF	727,25	s36	HYP	423,25
e54	UHF	735,25	s37	HYP	431,25
e55	UHF	743,25	s38	HYP	439,25
e56	UHF	751,25	s39	HYP	447,25
e57	UHF	759,25	s40	HYP	455,25
e58	UHF	767,25	s41	HYP	463,25
e59	UHF	775,25			

NEDERLANDS

FRANÇAIS

ESPAÑOL

VR 337

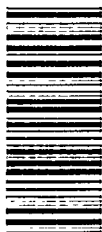

3103 166 10031
3404/001



OPERATING INSTRUCTIONS VR 337

Congratulations! You are now the owner of one of the most sophisticated and simple-to-use video recorders (VCR) on the market.

But please allow me to introduce myself. I am Philip and I should like to help you to get to know your new video recorder.

Naturally, you can't wait to use it, but before you do, it's worthwhile taking the time to read through these operating instructions. They will show you how to make the best use of your equipment.

You can practise using the video recorder without any worries because you cannot damage it no matter which buttons you press.



ENGLISH

Contents	Page
1. SUMMARY OF BUTTONS AND CONTROLS	2
2. INSTALLATION. HOW DO I INSTALL MY VIDEO RECORDER?	6
Emergency interrupt	9
Setting the display language	10
Setting the clock and date on the video recorder	10
3. PLAYING A RECORDED CASSETTE	12
4. STORING TV CHANNELS	17
Automatic channel search	17
5. HOW DO I RECORD DIRECTLY?	23
6. HOW DO I PROGRAMME A RECORDING?	26
Programming with ShowView	28
Programming on the video recorder	30
How do I check or correct a TIMER block?	33
7. SPECIAL FUNCTIONS AND EXTRAS ON YOUR VIDEO RECORDER	34
Playback via the aerial cable	38
8. BEFORE YOU CALL AN ENGINEER	41
9. TECHNICAL DATA, ACCESSORIES	42



1. SUMMARY OF BUTTONS AND CONTROLS

Here is a list of all the buttons, controls and sockets that you will find on the video recorder and the remote control.

You will find detailed descriptions concerning the various functions in the relevant chapters.

The remote control

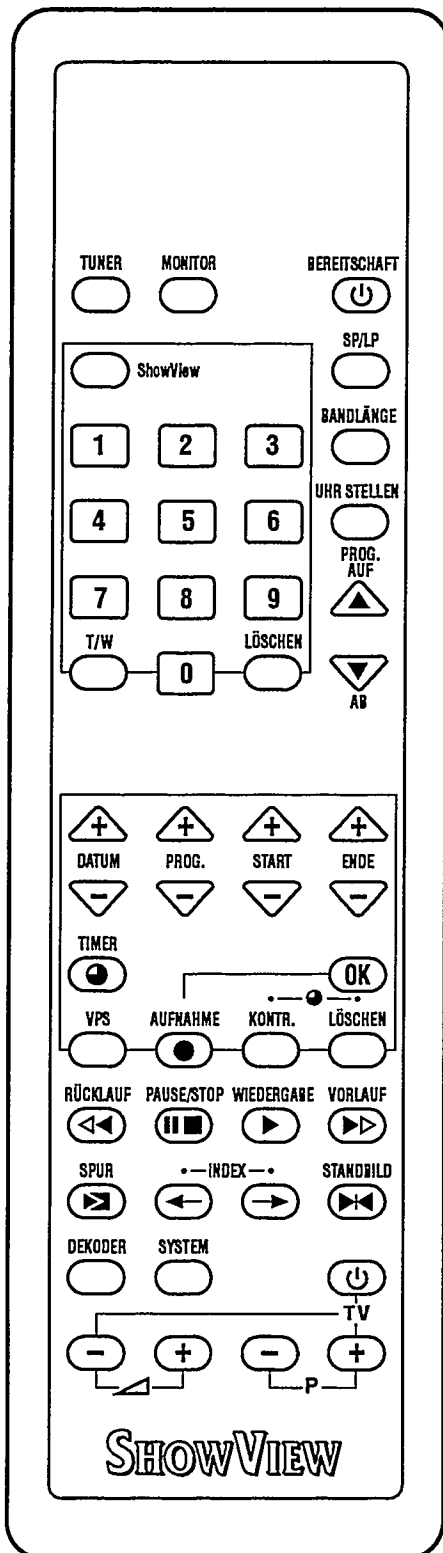

- TUNER** Tuner mode
- MONITOR** TV monitor function
- BEREITSCHAFT** ⏻ Switch off
- SP/LP** No function
- BANDLÄNGE** Tape length selector
- UHR STELLEN** Set clock on video recorder
- AUF** ▲ Up/Plus, programme number
- AB** ▼ Down/Minus, programme number
- SHOWVIEW** 'ShowView' programming
- 0-9** Digit buttons 0-9
- T/W** Daily/weekly programming
- LÖSCHEN** Reset/clear
- DATUM +/-** TIMER Date +/-
- PROG. +/-** TIMER Programme +/-
- START +/-** TIMER Start time +/-
- ENDE +/-** TIMER Stop time +/-
- TIMER** ● TIMER programming on the video recorder
- OK** Confirm button
- VPS** VPS on/off
- AUFNAHME** ● Record (**OK** and **AUFNAHME** ● buttons simultaneously)
- KONTR.** TIMER Control
- ◀ RÜCKLAUF** Rewind/Reverse scanning
- PAUSE / STOP** || ■ Pause/Stop
- WIEDERGABE** ▶ Playback
- VORLAUF** ▶▶ Wind/Forward scanning
- SPUR** ▶ Search function - previous mark
- INDEX** ◀ Search function - previous mark
- INDEX** ▶ Search function - next mark
- STANDBILD** ▶◀ Still picture
- DEKODER** Decoder on/off
- SYSTEM** No function

Additional TV functions: Only function with televisions with the same remote control code.

- P** Programme number + / -
- ▲** TV volume + / -
- ⏻** Switch off TV



Front of video recorder

- KASSETTE** [] Cassette eject
- AUFNAHME** [●] Record
- RUCKLAUF** [◀] Rewind/Reverse scanning
- AB** [▼] Down/Minus, programme number
- WIEDERGABE** [▶] Playback
- AUF** [▲] Up/Plus, programme number
- VORLAUF** [▶▶] Forward wind/Forward scanning
- AUTOSTORE** [] Store TV channel
- BEREITSCHAFT** [⏻] Switch off
- SENDER ORDNNEN** [] Programme 'Preset'
- PAUSE / STOP** [⏸] Pause/Stop

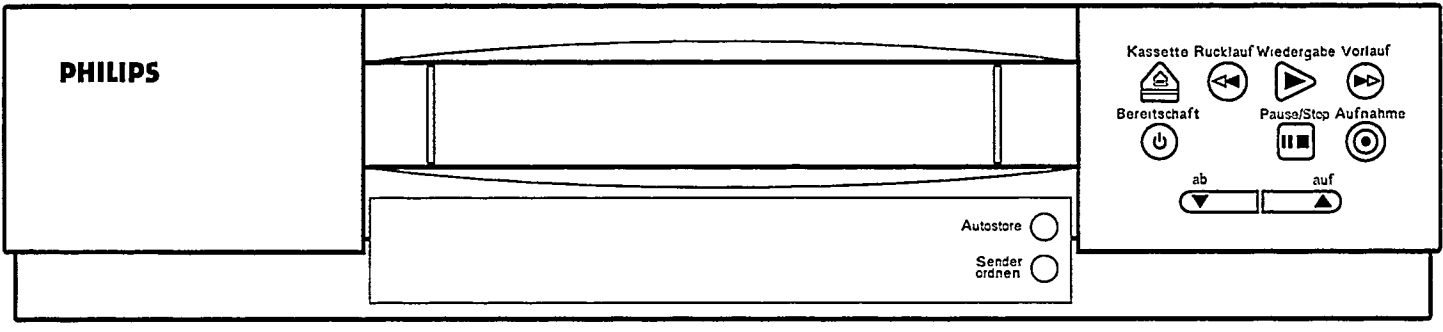

Back of video recorder

- [~]** Mains socket
- [EXT 1]** AV-Euro socket (Scart)
- [TV]** Aerial output socket
- [EXT 2]** AV-Euro socket (Scart)
- [T]** Aerial input socket
- [MOD. FREQ.]** Channel control
- [SIG]** Attenuator switch

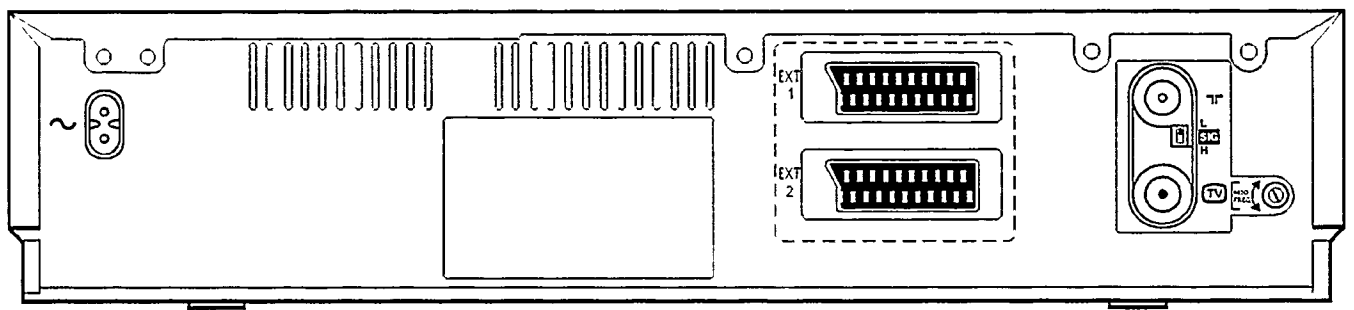

Safety instructions



- The manufacturer cannot be held responsible for any damage which is incurred by not using the video recorder in compliance with the national guarantee conditions and safety regulations.
- First check that the supply voltage indicated on the back of your video recorder is the same as your local supply voltage.
- Danger - high voltage in this appliance! Do not open! The video recorder does not contain any parts that can be repaired by the user. As long as your video recorder is connected to the mains there are parts of it still in operation. To switch off the video recorder completely you must disconnect it from the mains.
- Ensure that air can circulate freely through the ventilation slots of your video recorder. Do not place your video recorder on soft surfaces.
- Protect your video recorder from rain and damp. Ensure that no objects or liquids enter the equipment. If liquid is spilt into the video recorder, disconnect the video recorder from the mains immediately and call the After-Sales Service for advice.
- Do not place your video recorder close to a source of heat (radiator etc).

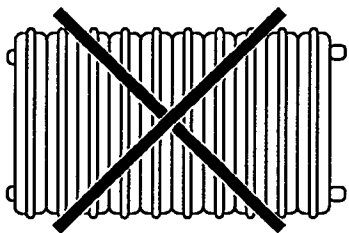

Precautions

- The video recorder should not be used immediately after transportation from a cold to a hot area or vice versa, or in conditions of extreme humidity. After unpacking your video recorder, it should be allowed to acclimatize for at least three hours before installation.



- Do not place your video recorder near appliances which generate strong magnetic fields (e.g.: motors, loud speakers or transformers).
- Do not use the video recorder in dusty places or where it may be subject to vibration. We recommend disconnecting the appliance from both the mains and the aerial  during heavy thunderstorms.
- Ensure that there is a vertical distance of at least 20 cm (8 ins) between the video recorder and your TV set.
- Do not put your fingers or any other foreign objects into the cassette slot as this could damage the mechanism. Particular care should be taken when children are present.
- If you have to move your video recorder, be sure to remove the video cassette from the cassette slot and avoid sudden or violent jolts.

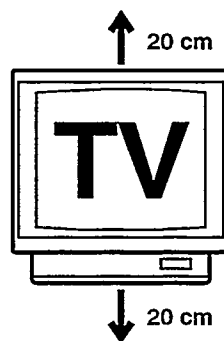
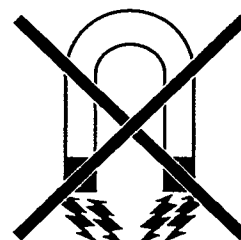

This video recorder employs the VHS cassette standard.
 Only use cassettes of a well-known brand which display the VHS symbol. We recommend that you use PHILIPS VHS video cassettes to ensure the best possible picture quality from your video recorder.



These operating instructions have been printed on chlorine-free paper. This is to help protect our environment.
 Used remote control batteries should not be thrown away with ordinary domestic refuse. Deposit old batteries at the relevant collection points.



ShowView is a trademark applied for by Gemstar Development Corp.. ShowView is manufactured under licence from Gemstar Development Corporation.



2. INSTALLATION. HOW DO I INSTALL MY VIDEO RECORDER?

How do I insert the batteries into the remote control?

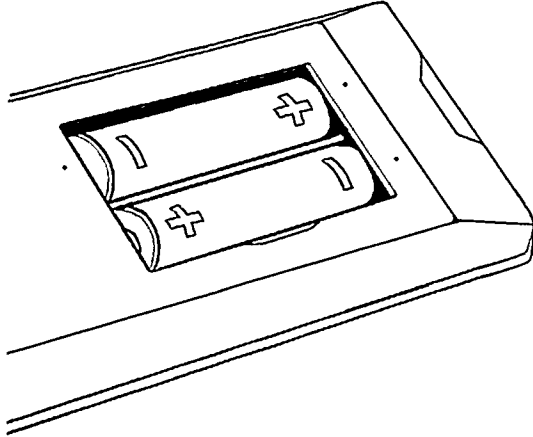

- 1 Remove the cover from the back of the remote control.
- 2 Insert the batteries as indicated into the battery compartment and close the cover.

Note:

* Do not use rechargeable batteries in this remote control.

To connect your video recorder

You will find a detailed explanation of this diagram in the following sections.

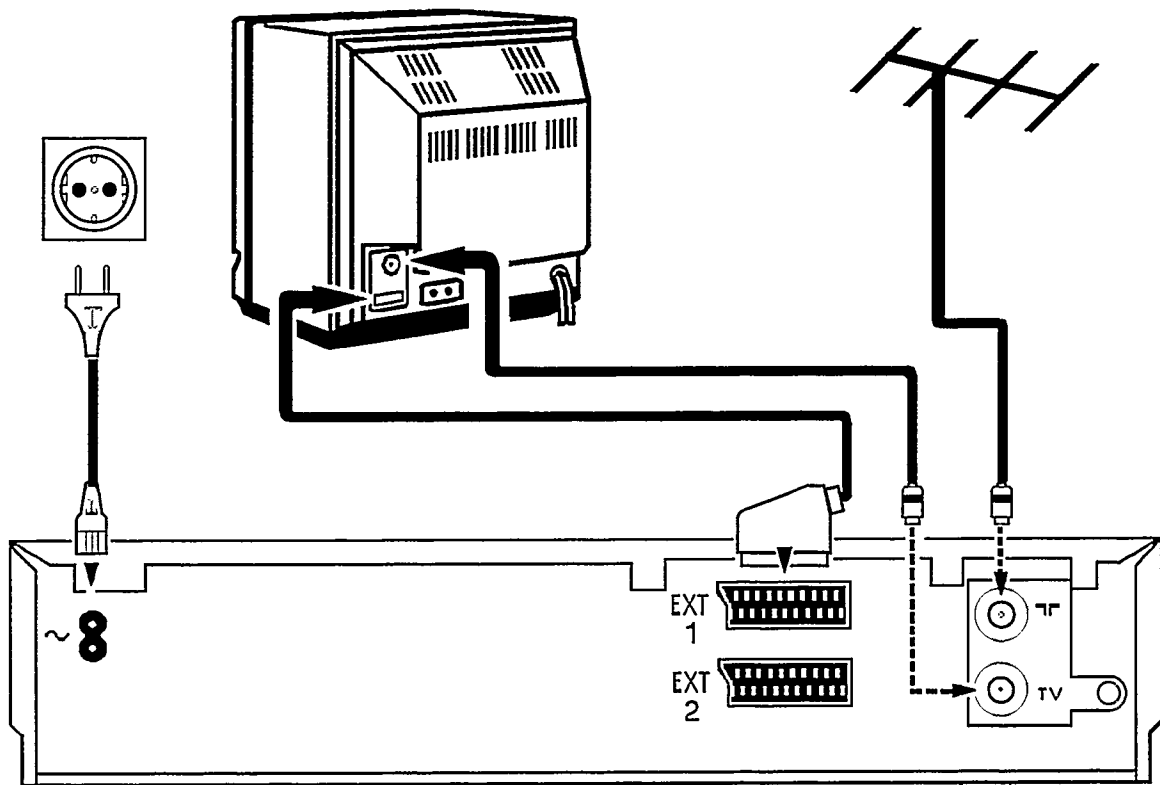

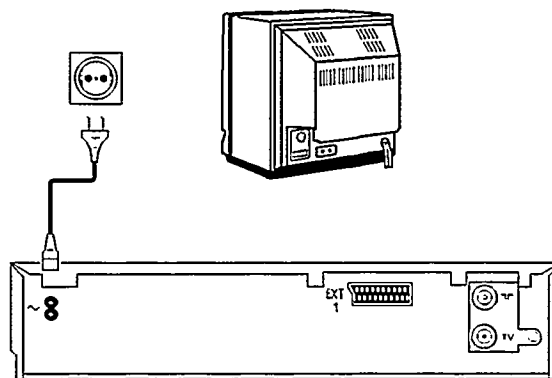

Connecting to the mains power supply

- 1 Insert the female plug of the mains cable into the mains socket  at the back of the video recorder.
- 2 Plug the other end of the mains cable into the wall socket.

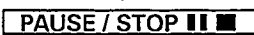

Some general notes for subsequent operation

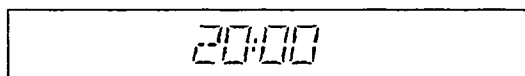

- Keep your video recorder connected to the mains at all times to ensure that programmed recordings can be made and that the television functions. The power consumption required for this is very low.
- The video recorder switches on automatically as soon as you insert a cassette or press the button .
- If you switch your video recorder off using the  button, the current time will appear in the display, e.g.: '20:00'.
If the clock has not been set, the display will flash.

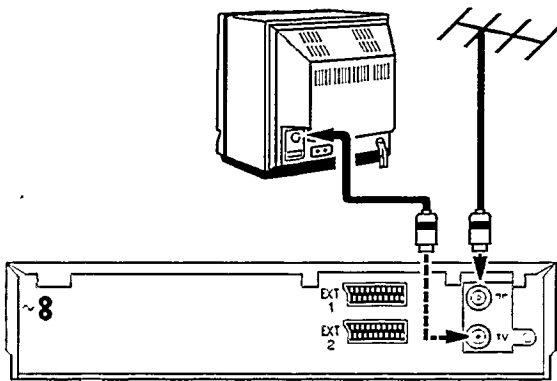

Connecting to the aerial

Your video recorder is actually a 'TV set without a screen'. Therefore, you must connect it to the aerial as well as to the TV set. Only then can you record TV programmes and play recorded cassettes.



- 1 Remove the aerial cable plug from your TV set and insert it into the socket  at the back of the video recorder.
- 2 Plug one end of the aerial cable provided into the  socket on the video recorder and the other end into the aerial input socket on your TV set.

Both the TV set and the video recorder are now connected to the aerial.



Connecting to the TV set

If your television does not have an AV-Euro (Scart) socket please do not read further here but turn to Chapter 7, 'Special functions and extras'. In the section 'Playback via the aerial cable' you will find further information.

- 1 Plug the orange-marked plug of the AV-Euro cable provided into the orange AV-Euro socket **EXT 1** at the back of your video recorder. Connect the other end to the TV set.
- 2 This cable connection causes many modern televisions to **automatically** switch to the 'EXT' (EXTernal) or 'AV' (Audio/Video) programme number when playing a video cassette.

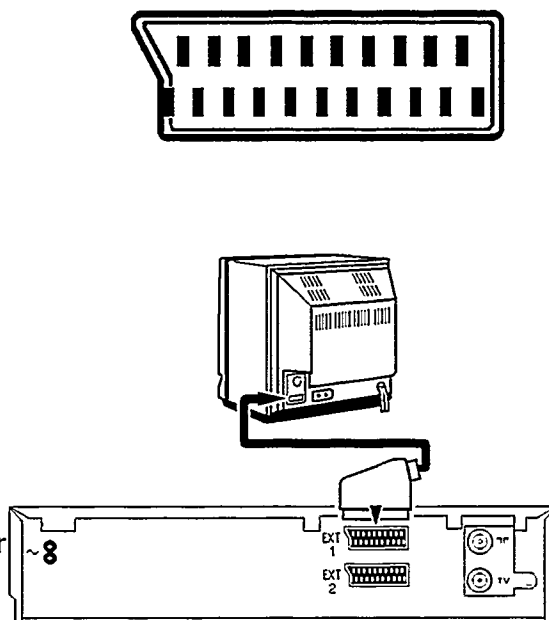

On older televisions you will have to select the 'EXT', '0', or 'AV' programme number on the TV set manually to play back from the video recorder. You will find instructions for this in the operation manual of your TV set.

Your video recorder is now **fully** connected to the TV set.

Emergency interrupt

Both the video recorder and the remote control have an 'Emergency interrupt' button. You can use the **BEREITSCHAFT**  button to interrupt any function. Whenever you have trouble operating the video recorder you can simply interrupt any function and start again. You can practise operating your video recorder without any worries. No matter which button you press, you won't damage the video recorder.

Setting the display language

You can choose from ten languages for the display on your video recorder.

- 1 Ensure that there is no cassette in the cassette slot. With your video recorder switched off, press the **KASSETTE** and **WIEDERGABE ▶** buttons simultaneously.
- 2 Use the **AB ▼** or **AUF ▲** button to select the required display language, e.g.: 'ENGLISH'.
- 3 Finally, press the **BEREITSCHAFT ⏻** button.



ENGLISH

Setting the clock and date on the video recorder

In order to be able to programme recordings, you must first ensure that the video recorder clock is correctly set. To do this, use the **AB ▼** or **AUF ▲** buttons on the remote control in all the following steps.

- 1 Press the **UHR STELLEN** button on the remote control. 'TIME' will appear in the video recorder display. Set the current time.
- 2 Press the **OK** button. 'YEAR' will appear in the display. Set the current year.
- 3 Press the **OK** button again. 'MONTH' will appear in the display. Set the current month.
- 4 Press the **OK** button again. 'DATE' will appear in the display. Set today's date.
- 5 Press the **OK** button again. The time and date have now been set. In confirmation, 'READY' will appear briefly in the display.



TIME 15:14



YEAR 1993



MONTH 06



DATE 1



READY 15:14



Connecting a decoder

Some TV broadcasters transmit encoded television signals which you can only see with a purchased or rented decoder. You can connect such a decoder (descrambler) to this video recorder.

- 1 Connect the decoder to the video recorder with an AV-Euro cable (EXT 2 socket).
You will find a description of how to store TV channels with the decoder in the chapter 'Storing TV channels'.
- 2 Connect the TV set to the EXT 1 socket.

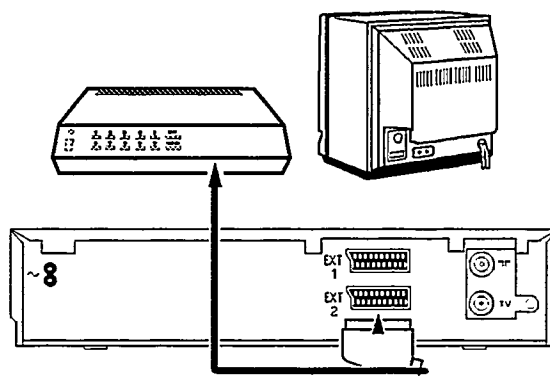

Note:

- * You cannot use the decoder with your video recorder and your TV set simultaneously.
- * On your video recorder select the programme number that you allocated to the decoder function when storing the channel numbers. The video recorder will then automatically use the decoder.

3. PLAYING A RECORDED CASSETTE



In Chapter 2 you connected your video recorder to your TV set. Playing a cassette is now very simple. If you want to record something straight away, first read Chapters 4 and 5.

- 1 Switch on your TV set.

Many modern TV sets **automatically switch over** to the video recorder programme number when a video is played.

However, this only works if your video recorder is connected to your TV set with an AV-Euro-cable. Otherwise select the programme number on your TV set which you have earmarked for video playback.

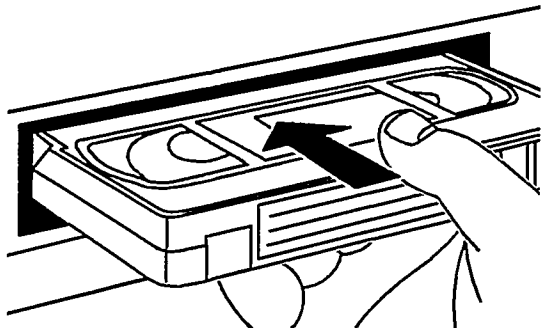

- 2 Insert the cassette into the cassette slot with the label facing towards you. The window must be facing upwards.

Press against the centre of the cassette until the cassette is automatically pulled inside. When you insert a cassette, the video recorder automatically switches itself on.

Only one side of VHS cassettes can be used for recording or playback.

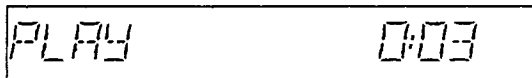

- 3 Press the Play button **WIEDERGABE ▶**. 'PLAY' will appear in the display.

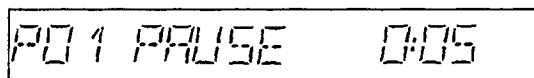

- 4 If you wish to interrupt playback, press the **PAUSE / STOP ||■** button. 'PAUSE' will appear in the display.

- 5 If you wish to remove the cassette, press the **KASSETTE** button.

Note:

* Each time a cassette is loaded or removed the video recorder automatically cleans the video heads. In this way the best playback quality is maintained.



Fast wind and rewind

- 1 Press the **PAUSE / STOP** button.
- 2 Press the **RÜCKLAUF** (Rewind) or **VORLAUF** (Wind) button. The tape is wound at high speed.
- 3 Press the **PAUSE / STOP** button as soon as you have reached the required position on the tape.



Picture scanning

You can select from various speeds for scanning backwards or forwards.

- 1 Press the **WIEDERGABE** button.
- 2 Now press the **RÜCKLAUF** or **VORLAUF** button as often as necessary until you have reached the desired speed.
The display will show: 'SCAN', 'FAST', 'REVERSE' or 'PLAY'.
- 3 Press the **WIEDERGABE** button once you have found the desired passage.

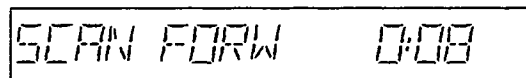
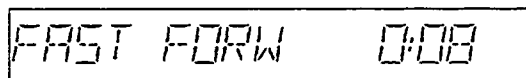

Note:

* The picture quality is affected during scanning. The sound is turned off. However, this does not mean that there is a fault.

Still picture/Super-slow motion

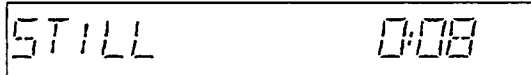

- 1 Press the **WIEDERGABE ▶** button on the remote control.
- 2 Press the **STANDBILD ▶◀** button. The picture will stand still.
Each time you press **STANDBILD ▶◀** again the picture will move on one step at a time.
Hold down the **STANDBILD ▶◀** button. The picture will be played in super-slow motion.
- 3 Press the **WIEDERGABE ▶** button to continue playing back at the normal speed.

Special note:

* If the still picture vibrates vertically, keep pressing the **SPUR ▶** button until the vibration disappears. If you pass the optimum setting, repeat this step with the **SPUR ▶** button.
You only have to find the optimum setting for your TV set once as the video recorder will store it automatically.
Please note, however, that interference may still occur with poor quality hired cassettes.
This is not a fault in your video recorder.

Slow motion

- 1 Press the **STANDBILD ▶◀** button.
The recording is shown as a still picture.
- 2 Press the **VORLAUF ▶▶** button several times. You have a choice of three slow motion playback speeds, i.e. 1/7th, 1/10th or 1/14th of normal playback speed.
When you press the **◀◀ RÜCKLAUF** button several times you will return to the still picture.
There is no sound during slow motion playback.



Tape position. How do I know where I am on the tape?

It is handy to know how long a tape has been playing. First enter the length of the loaded cassette. This must be done if the correct playing time is to be indicated. The tape length will be indicated in minutes, e.g.: 'E180' corresponds to 180 minutes of playing time. You will find the length printed on the left of the narrow front edge. The actual length, however, may be a little longer than indicated.

- 1 Press the **BANDLÄNGE** button on the remote control. A tape length will appear in the video recorder display, e.g.: 'CASSETTE E 180'.
- 2 Now press the **AUF ▲** or **AB ▼** button in order to select the right tape length. The alternatives will appear in this order: E30, E60, E90, E105, E120, E150, E180, E195, E200, E210, E240, E260, E300, EC30, EC45, E30 etc.
- 3 Point the remote control at the video recorder. Press the **OK** button on the remote control. This confirms the data.

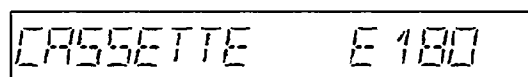

CASSETTE E 180

The elapsed playing time, given to the exact minute, appears in the display during Wind, Rewind, Record, Playback and Pause/Stop.



PLAY 0:03

Special Note:

* When you load a cassette, the video recorder must first calculate the playing time. Therefore, the display first indicates '- : -' and, then, shows the correct playing time only after the tape has been running for a few seconds.

* The time display only works accurately with European PAL/SECAM-VHS cassettes. Cassettes made for NTSC-VHS equipment do not show an exact time.

Searching for a tape position

Sometimes you may have recorded two or more TV programmes on one cassette.

So that you do not have to spend time searching, your video recorder offers you an automatic search facility.

The video recorder marks the tape with code marks every time you start to record. You can search for these code marks on the tape using the **INDEX ←** and **INDEX →** buttons on your remote control.

- 1 Press the **INDEX →** button to select the next code mark or the **INDEX ←** button for the previous code mark.



A rectangular display box containing the word 'NEXT' on the left and the time '0:58' on the right.

Either 'NEXT' or 'PREVIOUS' will appear in your video recorder display.

- 2 Once the video recorder finds the code mark it will automatically switch to playback.

Note:

* When you press any tape transport button (e.g.: the **WIEDERGABE ▶** or **PAUSE / STOP ||■** button) this search function will be stopped.

* You cannot use this function with recordings made on another video recorder that does not have this function.

How do I eliminate picture interference?

Every time a cassette is loaded the video recorder will **automatically** set the correct tracking position.

For recordings made on another video recorder you may be able to improve on the automatic setting as follows:

- 1 Press the **WIEDERGABE ▶** button on your remote control.
- 2 Press the **SPUR ▶▶** button on your remote control.
- 3 Press the **WIEDERGABE ▶** button as soon as the playback quality is at its best. This setting will remain until you remove the cassette.

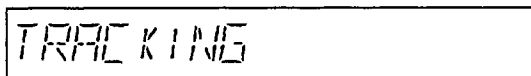

A rectangular display box containing the word 'TRACKING'.



4. STORING TV CHANNELS

In order to be able to record TV programmes you must first store all the TV channels (e.g.: 'BBC1') in your video recorder.

You can store up to 42 different TV channels.

Your video recorder has its own receiver. This means that it can be used independently of your TV set.

For the subsequent use of 'Programming with ShowView' you also have to allocate a so-called 'aerial code' to each TV channel. You will find a code table in your TV guide.

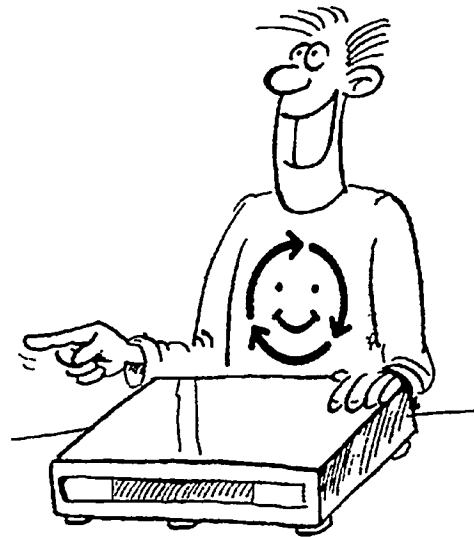

Automatic channel search

The video recorder will search for all TV channels at the same time and store them in its memory in the order in which it finds them.

- 1 Switch on the TV set.
Many modern TV sets **automatically switch** to the video programme number at step 2. However, this will only function if your video recorder is connected to the TV set with an AV-Euro cable.
Otherwise, select the video programme number on your TV set.
- 2 With the video recorder switched off, press the **AUTOSTORE** button on your **video recorder**. The automatic channel search function starts.
'AUTOSTORE' will appear in the display.
- 3 Wait until the video recorder has found all of the TV channels. This can take several minutes.
- 4 Identify the TV channel to which you are tuned.
Use the digit buttons **0-9** to allocate the correct 'aerial code' to it. You will find a code table in your TV guide.
If necessary, you can clear with button **LÖSCHEN**.
If you do not want, or cannot select, certain aerial codes at this time, you can also select them later with the function 'Allocating channel numbers'.

AUTOSTORE 00

P01 180,5 5% ----

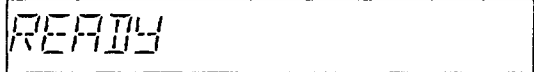

- 5 Confirm with button .
Once **all** of the TV channels have been located, 'READY' will appear in the display.
- 6 The channel search is now complete and all the TV channels have been stored.

Note:

- * After any subsequent activation of the search function, the newly-found TV channels will be added at the end of those previously stored.
- * When you activate the 'Automatic channel Search' function, any TIMER blocks which have been programmed will be cleared. This is not a fault in your video recorder.



Allocating channel numbers (Programme Preset)

You can allocate any desired programme number to the TV channels stored by the Automatic Channel Search. For example, so that they are in the same sequence as on the TV set.

- 1 Switch on your TV set.
Many modern TV sets **automatically switch** to the video programme number at step 2. However, this will only function if your video recorder is connected to the TV set with an AV-Euro cable.
Otherwise, select the video programme number on your TV set.
- 2 Press the **SENDER ORDNUM** button on your video recorder.
A frequency number and 'STORE P 01' will appear in the display.
You will find a 'Frequency Table' on the last page of this Operating Manual.
- 3 Use the **AUF ▲** or **AB ▼** button on your remote control to select the TV channel to which you wish to allocate programme number 'P 01'.

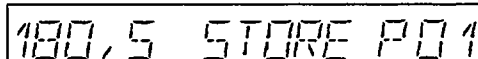

Note:

* Have you used an Euro-AV-cable to connect the video recorder to your TV set and does your TV set respond to the switch-over with the **MONITOR** button on the remote control? If so, you can switch to and fro between TV reception and video recorder reception. This is the easiest way for you to allocate the same TV channels to the same programme numbers on both appliances.

- 4 Confirm the allocation by pressing the **OK** button on the remote control.

P01 180.5 SV -----

- 5 Identify the TV channel to which you are tuned. Use the digit buttons **0-9** to select or change the 'aerial code' for ShowView . You will find a code table in your TV guide .
If necessary, you can clear with button **LOSCHEN** .

STORED

- 6 Confirm with button **OK** on the remote control. 'STORED' will appear briefly in the display.
- 7 The video recorder will now display the next programme number, 'P 02'. Repeat steps 3 to 6 until you have numbered all the TV channels.

If you wish to delete a TV channel, for instance, if the picture quality is too poor, press the **LOSCHEN** button instead of **OK** (step 4).

- 8 When you have finished, press the **SENDER ORDNER** button on your video recorder.

Note:



- * Unused (free) programme numbers cannot be selected.
- * By pressing the **VPS** button you can display the name of the TV channel, e.g.: BBC1, while you are allocating the channel numbers. Of course, the name can only be displayed when it is indeed being transmitted by the TV station.
- * If a TV station broadcasts encoded programmes and your video recorder is connected to a decoder, press the **DEKODER** button on the remote control at step 3 . 'DECODER' appears in the display. The video recorder will activate the decoder function from now on when you select this TV channel number (= this programme number).



* If you want to fine tune the automatic TV channel setting (step ③), press the button **SPUR** . Now you can use the +/- function to vary from the standard value '0' within a range of +4 to -4.
Important: Such fine re-tuning is only necessary and useful in **special cases**, e.g. when there are stripes on the picture in cable-TV systems. However, the picture and sound quality may deteriorate.

Manual channel search

In certain cases the Automatic Channel Search may not be able to find all of the TV channels (e.g. coded TV channels). You can then use this manual method to set the channels.

- ① Switch on the TV set and select the programme number for the video recorder.
- ② Press the **TUNER** button on the remote control.
- ③ Press the **SENDER ORDNER** button on the video recorder **for more than five seconds**.
- ④ Hold down the **AB**  or **AUF**  button on the remote control until you have found the right TV channel. A changing frequency number will appear in the display.
 You will find a 'Frequency Table' on the last page of this Operating Manual.

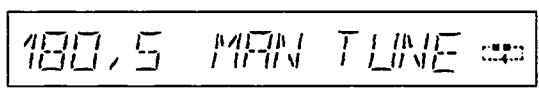
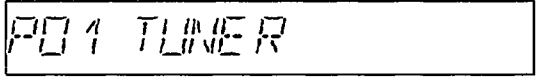

If the TV channel you have found is transmitted encoded and your video recorder is connected to a decoder, press the **DEKODER** button on your remote control. 'DECODER' appears in the video recorder display.

The video recorder will activate the decoder function from now on when you select this TV channel number (= this programme number).

180,5 STORE P01

5 Press the **OK** button on your remote control.

6 Use the **AB** or **AUF** button on your video recorder to select the programme number that you wish to allocate to this TV channel.

7 Press the **OK** button.

P01 180,5 5/1 ----

8 Identify the TV channel to which you are tuned. Use the digit buttons **0-9** to select or change the 'aerial code' for ShowView. If necessary, you can clear with button **LOSCHEN**.

STORED

9 Press the **SENDER ORDNEN** button. The TV channel is now stored.

10 Repeat steps 3 to 9 until you have stored all of the TV channels.

11 Switch off the video recorder by pressing the **BEREITSCHAFT** button.

Attenuator switch - SIG

You should normally leave the attenuator switch at the back of the appliance in the **L** position.

Only use the **H** position if there is a great deal of interference when receiving TV stations with strong signals.

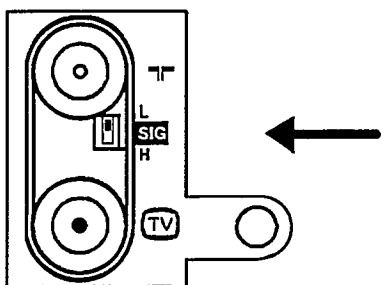

5. HOW DO I RECORD DIRECTLY?

The easiest way to record is to directly record a TV programme that is currently being transmitted. And this is how to go about it:

- 1 Insert a cassette. The video recorder will switch on automatically. You can also switch it on with the **PAUSE / STOP** button.
- 2 Use the **AUF** or **AB** button to select the programme number from which you wish to record, e.g.: 'P 01'.
- 3 When you wish to start recording, press the **AUFNAHME** button on your video recorder. If you use the remote control, press the **OK** and **AUFNAHME** buttons **simultaneously**. This protects against erroneous recording.

'RECORD' appears in the video recorder display. The video recorder will record the required TV programme.

- 4 To stop recording, press the **PAUSE / STOP** button.

Can I switch off the TV set during recording?

Yes! Your video recorder has its own receiver which enables it to record TV programmes. This means that you can use the TV set independently of the video recorder whilst recording. You can switch it off and on or watch another TV channel without disturbing the recording.

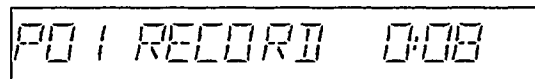

Some general notes:

* Programme numbers 'E 1' and 'E 2' are provided for recording from external sources (via the 'EXT 1 or 2' AV-Euro socket).

* Have you started to record one TV programme and now want to switch to another TV channel to record a different TV programme? To do this, you have to interrupt the current recording by pressing the **PAUSE / STOP** button. Now select the new programme number and start this recording by pressing the **AUFNAHME** button.

* If you have forgotten to load a cassette, the warning 'NO CASSETTE' will appear in the display.

* If you accidentally load a cassette with erase protection and try to record on it, the warning 'PROTECTED CASS' will appear in the display.

After a few seconds the cassette will be automatically ejected.

* If the end of the cassette is reached during recording, the cassette will be automatically ejected. The video recorder will then switch itself off after a few minutes.

* When you make a new recording on a video cassette, it will automatically record over and delete any recordings already on the cassette.

Erase protection

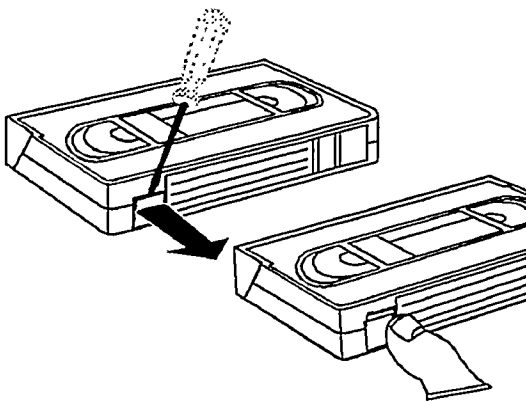

So that you don't accidentally delete an important recording, you can remove the special tab (erase protection) on the narrow side of the cassette with a screwdriver.

Later, if you no longer want the cassette to be erase protected, you can seal the gap again with adhesive tape.



Auto-assembling

You can use the auto-assembling function to join individual recordings without any annoying flickering between the recordings.

- 1 Press the **WIEDERGABE ▶** button. Search for the correct position on the tape and then stop the playback by pressing the **PAUSE / STOP ■■ ■** button. 'PAUSE' will appear in the display.
- 2 Now start recording as usual by pressing the **AUFNAHME ●** button.

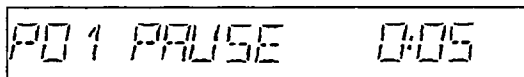

P01 PAUSE 0:05

6. HOW DO I PROGRAMME A RECORDING?



In this chapter you will learn how to programme your video recorder. It switches itself on automatically, records the TV programme you want and then automatically switches itself off again.

What information does the video recorder need?

You must give the video recorder the following information for every programmed recording you want to make:

- * the date on which the recording is to be made
- * the programme number for the TV channel
- * the start time of the recording
- * the stop time of the recording
- * VPS on or off

The video recorder stores all the information it needs for recording in what is known as a TIMER block. And you can set this up to one month in advance.

Your video recorder can store up to 6 of these TIMER blocks.

Please note that the timing of the TIMER blocks must not overlap. The video recorder must first finish one TIMER block before starting the next block.



What is VPS (Video Programming System)?

With VPS, the TV station controls when the video recorder is switched on and off. This means that the video recorder switches on and off at the right time even if a TV programme you have programmed begins earlier or finishes later than expected.

Assuming, that is, that the TV station actually transmits VPS.

Not all TV stations transmit a VPS signal.

You can see if a TV station is transmitting a VPS time code by the indication 'VPS' that appears in the display in the 'STOP' or 'PAUSE' mode.

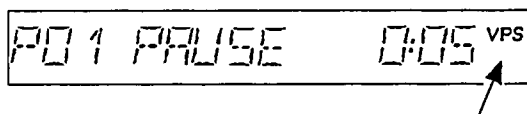

Please pay close attention to the VPS information alongside the individual TV programmes in your TV guide. Usually the start time and the VPS time code are the same. If, however, in the TV guide, in addition to a TV programme's start time, a different VPS time code is given, e.g.: '20.15 (VPS 20.14)', you have to enter '20.14' as the start time when programming the VPS time code and switch on VPS.

This is because a VPS recording will only function if you set the VPS time code to the exact minute.

If you want to set a time which differs from the VPS time code, you must switch off the VPS indication with the VPS button in the following section.

Note:

* VPS only functions faultlessly with good TV reception. When reception is poor, some programmed recordings with VPS may not function correctly. This is not a fault in the video recorder.

SHOWVIEW

Programming with ShowView

With this method the programming will be as easy as dialing a telephone number. You only have to select the 'ShowView code' (2 to 9 digits) printed in your TV guide next to the start time of a TV programme.

Make sure beforehand that the internal clock and the aerial codes are set.

- 1 Press button **SHOWVIEW** on the remote control.

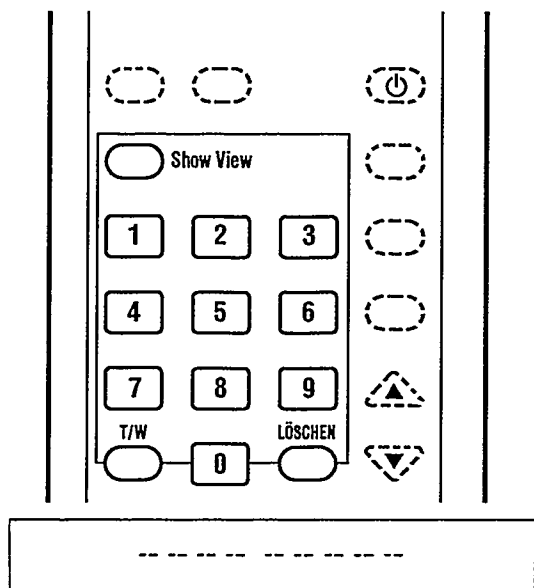

The video recorder display shows a series of dashes. To exit from this function press button **LÖSCHEN**.

- 2 Enter the entire 'ShowView code' with the digit buttons **0-9**. This code (2 to 9 digits) is found next to the start time of a TV programme in your TV guide.

If you entered an incorrect code number, clear it with button **LÖSCHEN**.

- 3 If you want to repeat programming at daily or weekly intervals, press button **T/W** once or twice. The display shows an additional 'DLY' (= daily) or 'WLY' (= weekly). The 'daily' function can only be used for recordings to be made on Mondays to Fridays inclusive.

- 4 Press the button **SHOWVIEW**. The programmed code is now decoded by the video recorder. If the video recorder has decoded correctly, the display shows the resultant data. The time is shown in the 24 hour mode.

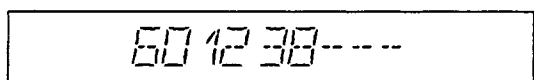

If necessary the data can now be changed with buttons

DATUM +/-, **PROG. +/-**, **START +/-** and **ENDE +/-**.

If you use 'VPS' take care that the display shows 'VPS'. Switch VPS on or off with button **VPS**.

5 Confirm the correct data with button **SHOWVIEW**.

TIMER READY ■

Note:

* To identify a TV channel correctly the video recorder needs the correct 'aerial code' for ShowView. If this is missing, the video recorder display shows 'SV UNKNOWN' and then the programme number 'E 2'.

You then have two possibilities:

1. To interrupt programming. Press button **LÖSCHEN** twice. Then enter, as described in Chapter 4, 'Storing TV channels', section 'Allocating channel numbers', the correct aerial code and repeat the programming.

2. To use programme number 'E 2' to record from an external source (e.g. satellite tuner). Confirm the data displayed in step 4 with button **SHOWVIEW**.

* If you cannot find, or do not want to use, the aerial code for certain TV channels, then you must use the programming method described in the next section.

* If 'CODE ERROR' appears in the display, the code was incorrect or incorrectly entered. Repeat the entry or end with button **BEREITSCHAFT** .

* If 'SET CLOCK' appears in the display, the internal clock is not set. Set the clock.

* 'Daily' programming can only be used for recordings to be made from Mondays to Fridays inclusive.

* 'Daily/Weekly' programming can only be used up to one week in advance.

Programming on the video recorder

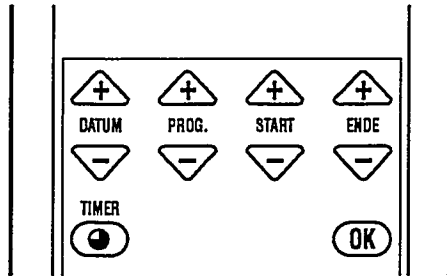

You can enter and store data for **six** recordings in your video recorder.

The video recorder display will indicate all data simultaneously. Use the four **+/-** buttons on the remote control to enter the data.

The data will be stored in the next free **TIMER** block in the video recorder.

Make sure you have not loaded a cassette with erase protection.

❶ Press the **TIMER** button on the remote control.

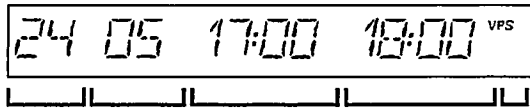

A free **TIMER** block will appear in the video recorder display. You will see the current (= today!) data for the date, programme number, start time and stop time.

Change the data in **any** sequence you choose:

- Set the date of the recording with the **DATUM +/-** button.
- Set the programme number with the **PROG. +/-** button.
- Set the start time with the **START +/-** button.
- Set the stop time with the **ENDE +/-** button.
- Switch VPS on or off with the **VPS** button.

❷ Have you set **all** the data correctly? Now press the **OK** button on the remote control.

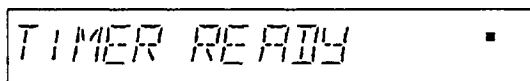

As confirmation, 'TIMER READY' appears in the video recorder display.

Programming is now complete.

The data has been stored in a **TIMER** block. One of the squares on the right-hand side of the display lights up for each **TIMER** block that is occupied.



Some **general** programming notes:

- * The **TIMER** record function will only work when the video recorder is **switched off**. If the video recorder is switched on before a programmed recording is due to take place, the warning 'TIMER RECORD' will light up on the display.
- * If the end of the cassette is reached during a programmed recording, the video recorder automatically ejects the cassette.
- * If you forget to load a cassette after programming, 'NO CASSETTE' will appear in the video recorder display.
- * If you insert a cassette with erase protection for the recording, 'PROTECTED CASS' will appear in the video recorder display for a few seconds. The cassette will then be ejected.
- * If you have programmed all **TIMER** blocks, 'MEMORY FULL' will appear in the video recorder display.



How do I record from a satellite tuner?

You can also programme recordings from an external satellite tuner.

- 1 Connect the tuner to the **EXT 2** socket. Make sure that the tuner is switched on and that the correct SAT channel has been selected.
- 2 Use one of the two available programming methods to programme a **TIMER** block. Use programme number 'E 2' in the programming procedure for this external recording source.

Note:

* If you use 'ShowView programming' for such an 'external' satellite TV programme, the video recorder automatically selects 'E 2'.
The error message 'SV UNKNOWN' can be ignored.

How do I stop a **TIMER** recording?

You cannot operate the video recorder manually while a programmed recording is being made.

If you want to stop the programmed recording, press the **BEREITSCHAFT**  button.



How do I check or correct a TIMER block?

- 1 Press the **KONTR.** button on the remote control.
- 2 Now press the **KONTR.** button as often as necessary until the TIMER block you want to check or correct appears in the video recorder display. The TIMER blocks will appear in chronological order on the display.
- 3 Now press the buttons **DATUM +/-**, **PROG. +/-**, **START +/-**, **ENDE +/-** to change the recording date, programme number, start time or stop time. You can switch VPS on and off. You can select from daily/weekly/date programming with button **T/W**.
- 4 Finally, press the **OK** button. If you have made any changes, the data will now be up to date. 'TIMER READY' will appear in the video recorder display.

TIMER READY ■

Note:

- * 'Daily' programming can only be used for recordings to be made from Mondays to Fridays inclusive.
- * 'Daily/Weekly' programming can only be used up to one week in advance.

How do I clear a TIMER block?

- 1 Press the **KONTR.** button on the remote control.
- 2 Press the button **KONTR.** as often as necessary until the TIMER block you want to clear appears in the video recorder display.
- 3 Press the **LOSCHEN** button. The TIMER block will be cleared. 'TIMER CLEARED' will appear in the video recorder display.

TIMER CLEARED



7. SPECIAL FUNCTIONS AND EXTRAS ON YOUR VIDEO RECORDER

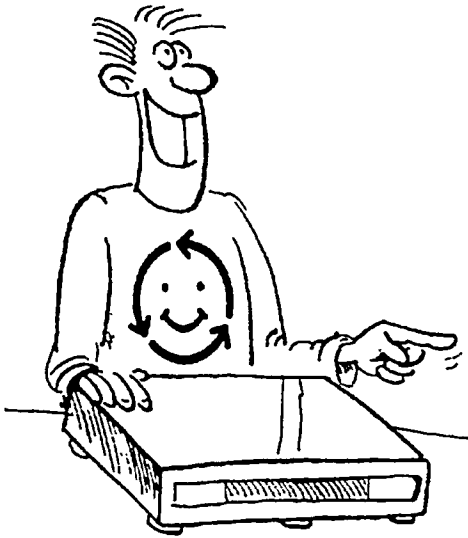

Apart from the functions that have already been described, your video recorder has other special functions and extras designed to make the use of your video recorder as convenient as possible.

In this chapter you will find out more about them.

Tuner mode. Your video recorder as an extension of your TV set

You can also use your video recorder as a TV receiver (tuner). This is handy if your TV set does not have remote control or if it has fewer storage places for TV channels than the number of TV channels it could actually receive.

This is how you go about it:

- 1 Switch on the TV set. Select the programme number you have earmarked for playback on the video recorder.
- 2 With the video recorder switched off, press button **TUNER** on the remote control. 'TUNER' and a programme number will appear in the display.
- 3 Choose the required programme number with the **AUF ▲** or **AB ▼** button.
- 4 Switch the video recorder off by pressing the **BEREITSCHAFT ⏻** button when you no longer want to watch television.

P01 TUNER



Channel name display

When you are watching or recording from TV channels that transmit the VPS signal, you can display the name of the TV channel (e.g.: 'BBC1') on the TV screen.

- 1 Press the **VPS** button.

Note:

* You can use this function in the Pause, Stop, Record, Programme Preset and Tuner modes.

View Mode

When you connect another appliance to the **EXT 2** socket you will be able to use the following additional functions. The appliance can be a second video recorder, a decoder, a satellite receiver or a CD video player.

- Thus, if the second appliance transmits a control signal, for example, during playback, the (switched on) video recorder will recognize it and automatically switch to 'View Mode'.
You can switch View Mode on and off with the **MONITOR** button.
- Even when the video recorder is switched off, the AV-Euro connection from the TV set to the second appliance is still operational.

Note:

* If you have selected the programme number 'E 1' or 'E 2', the video recorder cannot switch over to View Mode. This also applies to programme numbers for which the decoder function has been activated.

* The function reacts **only** if your TV set also has this switch-over function and you are using an AV-Euro cable to connect your video recorder to the TV set.

TV monitor function

Switch your TV set to the 'AV' programme number (Audio/Video input) by pressing the **MONITOR** button. This enables you to see the picture from the video recorder on the TV screen. Your video recorder must be switched on.

VCR MONITOR

'VCR MONITOR' will appear in the display for a few seconds. Press the button again to switch the monitor function off again.

Note:

* The monitor function will respond **only** if your TV set also has this switch-over function and you are using an AV-Euro cable to connect your video recorder to the TV set.

* The monitor button does not respond during playback.

Automatic switch-off

If the video recorder is not operated for a period of several minutes during one of the following functions, the function will be switched off.

This protects your cassette and prevents unnecessary power consumption.

If the video is:

in 'STOP'	it switches off
in 'NO CASSETTE'	it switches off
in 'STILL'	it switches to 'PLAY'
in, e.g., 'SCAN'	it switches to 'PLAY'
in 'PAUSE'	it switches to 'STOP'
in 'SLOW MOTION'	it switches to 'PLAY'



Recording from another video recorder

With this video recorder you can make recordings from an external source, such as copying from another video recorder or a camcorder.

To do this you will need an AV-Euro cable (Scart cable).

- 1 Connect your video recorder to the appliance from which you want to record, e.g.: another video recorder.

Plug the AV-Euro cable into the AV-Euro socket on each appliance. This is the **EXT 2** socket on this video recorder.

Note:

* In the following description, this video recorder will be the one used for recording and will be referred to as VCR B. The other appliance will be used for playback and will be referred to as VCR A.

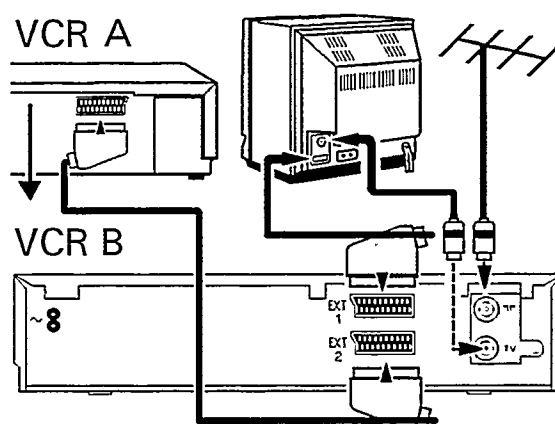

- 2 Insert the recorded cassette into VCR A and a blank cassette into VCR B.
- 3 Now select programme number 'E 2' on VCR B. This is found near to programme number 'P 01' (P 01 - E 1 - E 2). To do this, you use the **AUF ▲** or **AB ▼** button.
- 4 To start recording, press the recording button **AUFNAHME ●** on VCR B and the playback button **WIEDERGABE ►** on VCR A.
- 5 When you want to finish copying, press the stop button **PAUSE / STOP ■■ ■■** on both video recorders.

Playback via the aerial cable

If your TV set **does not have** an AV-Euro socket, the **aerial cable which is already connected** will act as the connection between your TV set and the video recorder.

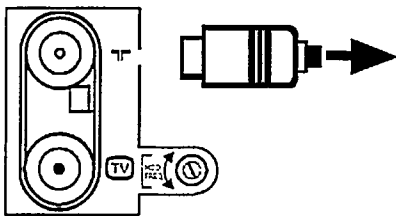

- 1 Switch your TV set on and select the programme number that you have earmarked for video playback. (You will find instructions for this in the operating manual for your TV set).
- 2 Disconnect the aerial cable from the aerial socket  of the video recorder so that only the cable connection between the TV set and the video recorder remains.
- 3 Make sure the video recorder is switched off and that there is no cassette in the cassette slot. Press the **KASSETTE** and **WIEDERGABE ▶** buttons simultaneously. The display language you have selected will appear in the display, e.g.: 'ENGLISH'.
- 4 Press the **OK** button. The video recorder will now transmit a test picture which should be received by the TV set. 'TESTPICTURE' will appear in the display.
- 5 Tune in the TV set in the UHF wave band until this test picture appears. The video recorder is tuned to UHF channel 36 in our factory.

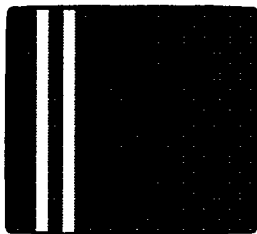

In order to find out how to tune to the right channel and to store this on your TV set, please consult the operating manual for your TV set.

Note:

* Check the sound and picture quality of reception on your TV set next time you play back from the video recorder. If necessary you can improve the picture, colour and sound by adjusting the channel on your TV set.



- 6 Plug the aerial cable back into the aerial socket . You have now tuned your TV set to the video recorder.

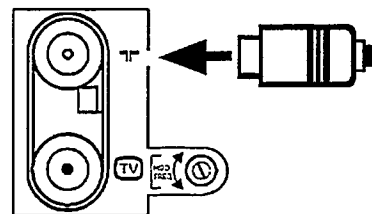



Information: Your video recorder occupies UHF channel 36. However, this channel might already be occupied by another TV station in your reception area.

In this case you will find that the picture quality on your TV set will be poor when receiving one or more TV channels.

If this happens, follow these steps:

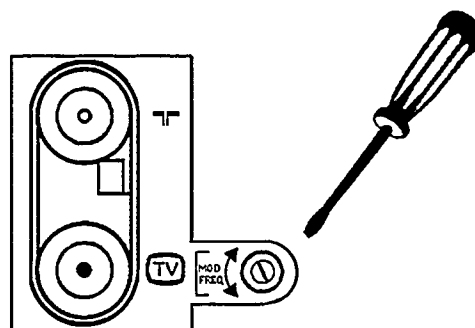
- 7 Check that the quality of reception on all the TV channels stored in the TV set remains unchanged.
- 8 If the picture quality of one or more TV channels has deteriorated, switch off the video recorder. Check all the TV channels on your TV set once again.
- 9 If the picture quality only deteriorates when the video recorder is switched on, adjust the channel control **MOD. FREQ.** at the back of the video recorder by less than a quarter-turn with a small screwdriver.



- 10 Re-tune the TV set to the video recorder (steps 2 to 6) until the test picture re-appears.
- 11 Check all the TV channels on your TV set again. Repeat the channel adjustment **MOD. FREQ.** (steps 9 and 10) until the picture quality is the same whether the video recorder is on or off.
- 12 Switch off the video recorder with the **BEREITSCHAFT**  button.

Note:

* If you have not yet set the time/date and the display language as described in Chapter 2, 'INSTALLATION', turn to that chapter to do so.

Switching the built-in modulator on or off

In the last section we talked about interference that could occur on the television. If you **cannot eliminate** picture or sound interference using the above method you can switch off the built-in modulator.

You can only do this if you have connected the video recorder to the TV set using an AV-Euro cable.

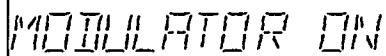

MODULATOR ON

- 1 Press the **KASSETTE** and **PAUSE / STOP** buttons on the video recorder simultaneously. The switch's current position will appear in the display as 'MODULATOR ON' .
- 2 Press the **KASSETTE** and **PAUSE / STOP** buttons simultaneously again for more than five seconds. This will switch to 'MODULATOR OFF' . Switch the modulator back on in the same way.



8. BEFORE YOU CALL AN ENGINEER

Problem

The video recorder does not respond to any button being pressed

Possible cause

- * No power supply
- * Programmed recording is currently being made
- * Technical disturbance: disconnect from the mains for 30 seconds, then re-connect. If this does not have any effect, you can: 1. Disconnect from mains. 2. Re-connect to mains **whilst holding down** the **◀◀ RÜCKLAUF**, **VORLAUF ▶▶** and **AB ▼** buttons. All data stored will be reset (cleared).

Remote control does not work

- * Batteries are exhausted
- * Interference from fluorescent lights or bright sunlight

No playback on video recorder

- * No recording on the cassette
- * The VCR programme number on the TV set was incorrectly selected or incorrectly set
- * The connecting cable between the TV set and the video recorder has come loose
- * Modulator not in the 'ON' position

Poor playback from video recorder

- * Use **SPUR ▶** with hired cassettes
- * Cassette badly worn or of poor quality
- * Channel control **MOD. FREQ.** or TV set not properly adjusted
- * Video heads dirty. Load - play briefly - remove a cassette several times. This activates the head cleaning function

Video recorder will not record

- * TV channel not stored or wrongly selected
- * Cassette with erase protection has been loaded

Programmed recording does not work

- * Time data wrongly programmed
- * Time/date not set properly
- * A cassette with erase protection has been loaded
- * Video recorder in Tuner Mode
- * VPS switched on but VPS time code wrong

Picture or sound interference on TV reception

- * Try setting the SIG attenuator switch to the **H** position.
- * Turn to the Chapter 'Special Functions and Extras' and read the **Note** after step 6 in the section 'Playback via the aerial cable' as well as the section 'Switching off the modulator'.



9. TECHNICAL DATA, ACCESSORIES

Technical Data

- Mains voltage 220 to 240 V
 - Mains frequency 48 - 52 Hz
 - Power consumption typically 15 W (typically 12 W in standby)
 - Wind/rewind time typically 95 sec. for E-180
 - Ambient temperature during operation +10°C to +35°C
 - Relative humidity 20% to 80%
 - Dimensions 380 x 338 x 86 mm (incl. feet)
 - Weight approx. 4.6 kg
 - Position for use max. 15° inclination on all sides
 - VHS video resolution \geq 240 lines
 - Audio (SP) 80 Hz - 10 KHz (\leq 8 dB)
 - Back-up power supply: TV channel storage - typically 1 year Clock/Timer - typically 7 hours
- This video recorder complies with the EC radio interference regulations (82/499/EEC).

List of accessories

- Aerial cable
- Mains cable
- Operating instructions
- Remote control and batteries
- AV-Euro cable (Scart cable)

In order to facilitate the identification of your video recorder in case of theft, enter the serial number (SER.NR.) in the diagram. The serial number is printed on the type plate fixed at the rear of your video recorder. All enquires can be handled more efficiently if accompanied by the identity card shown. This is provided for your reference and should be kept in a safe place.

TYPE	VR 337
WD xx	SER.NR.







Table of channel frequencies
PAL-B,G:

channel	wave-band	frequency (Mhz)	channel	wave-band	frequency (Mhz)
e2	VHF I	48,25	e60	UHF	783,25
e3	VHF I	55,25	e61	UHF	791,25
e4	VHF I	62,25	e62	UHF	799,25
e5	VHF III	175,25	e63	UHF	807,25
e6	VHF III	182,25	e64	UHF	815,25
e7	VHF III	189,25	e65	UHF	823,25
e8	VHF III	196,25	e66	UHF	831,25
e9	VHF III	203,25	e67	UHF	839,25
e10	VHF III	210,25	e68	UHF	847,25
e11	VHF III	217,25	e69	UHF	855,25
e12	VHF III	224,25	-	VHF I	69,25
-	VHF I	53,75	-	VHF I	76,25
-	VHF I	62,25	-	VHF I	83,25
-	VHF II	82,25	-	VHF II	90,25
-	VHF III	175,25	-	VHF II	97,25
-	VHF III	183,25	-	VHF II	104,25
-	VHF III	192,25	s1	VHF I	105,25
-	VHF III	201,25	s2	VHF III	112,25
-	VHF III	210,25	s3	VHF III	119,25
e21	UHF	471,25	s4	VHF III	126,25
e22	UHF	479,25	s5	VHF III	133,25
e23	UHF	487,25	s6	VHF III	140,25
e24	UHF	495,25	s7	VHF III	147,25
e25	UHF	503,25	s8	VHF III	154,25
e26	UHF	511,25	s9	VHF III	161,25
e27	UHF	519,25	s10	VHF III	168,25
e28	UHF	527,25	s11	VHF III	231,25
e29	UHF	535,25	s12	VHF III	238,25
e30	UHF	543,25	s13	VHF III	245,25
e31	UHF	551,25	s14	VHF III	252,25
e32	UHF	559,25	s15	VHF III	259,25
e33	UHF	567,25	s16	VHF III	266,25
e34	UHF	575,25	s17	VHF III	273,25
e35	UHF	583,25	s18	VHF III	280,25
e36	UHF	591,25	s19	VHF III	287,25
e37	UHF	599,25	s20	VHF III	294,25
e38	UHF	607,25	s21	HYP	303,25
e39	UHF	615,25	s22	HYP	311,25
e40	UHF	623,25	s23	HYP	319,25
e41	UHF	631,25	s24	HYP	327,25
e42	UHF	639,25	s25	HYP	335,25
e43	UHF	647,25	s26	HYP	343,25
e44	UHF	655,25	s27	HYP	351,25
e45	UHF	663,25	s28	HYP	359,25
e46	UHF	671,25	s29	HYP	367,25
e47	UHF	679,25	s30	HYP	375,25
e48	UHF	687,25	s31	HYP	383,25
e49	UHF	695,25	s32	HYP	391,25
e50	UHF	703,25	s33	HYP	399,25
e51	UHF	711,25	s34	HYP	407,25
e52	UHF	719,25	s35	HYP	415,25
e53	UHF	727,25	s36	HYP	423,25
e54	UHF	735,25	s37	HYP	431,25
e55	UHF	743,25	s38	HYP	439,25
e56	UHF	751,25	s39	HYP	447,25
e57	UHF	759,25	s40	HYP	455,25
e58	UHF	767,25	s41	HYP	463,25
e59	UHF	775,25			



